



ITALY AND OTHER COUNTRIES
SILCA S.p.A.
 Via Podgora, 20 (Z.I.)
 31029 VITTORIO VENETO (TV)
 Tel. +39 0438 9136
 Fax +39 0438 913800
 E-mail: silca@silca.it
www.silca.biz - www.silca.it

GERMANY
SILCA GmbH
 Siemensstrasse, 33
 42551 VELBERT
 Phone: +49 2051 2710
 Fax +49 2051 271172
 E-mail: info@silca.de
www.silca.de

UNITED KINGDOM
SILCA Ltd.
 Unit 6 Lloyds Court
 Manor Royal
 CRAWLEY RH10 9QU
 Phone: +44 1293 531134
 Fax +44 1293 531108
 E-mail: sales@silcald.co.uk
www.silcald.co.uk

SPAIN
SILCA KEY SYSTEMS S.A.
 C/Santander 73A
 08020 BARCELONA
 Phone: +34 93 4981400
 Fax +34 93 2788004
 E-mail: silca@silca.es
www.silca.es

FRANCE
SILCA S.A.S.
 12, Rue de Rouen
 Z.I. Limay-Porcheville
 78440 PORCHEVILLE
 Phone: +33 1 30983500
 Fax +33 1 30983501
 E-mail: info@silca.fr
www.silca.fr

BENELUX
H. CILLEKENS & B.V.
 Metaalweg, 4
 6045 JB ROERMOND
 Phone: +31 475 325147
 Fax +31 475 323640
 E-mail: info@hcillekens.nl
www.hcillekens.nl

UNITED KINGDOM
ADVANCED DIAGNOSTICS Ltd.
 Eastboro Fields
 Hemdale Business Park
 CV11 6GL NUNEATON
 Phone: +44 2476 347000
 Fax + 44 2476 347100
 E-mail: sales@advanced-diagnostics.com
www.advanced-diagnostics.com



dormakaba Group



UNOCODE *F900*

MAKE EVERY MINUTE COUNT WITH SILCA'S UNIQUE UNOCODE F900

Designed for specialist locksmiths, Silca's latest electronic key cutting machine automates and simplifies the complete key duplication process to improve the speed and quality of service to your customer. Faster key duplication means significantly improved returns on each key sold for you.

The exclusive Unocode F900 is the truly all-in-one solution for duplicating flat keys, automating the key feeding, engraving, cutting and sorting leaving you free to manage your next customer.

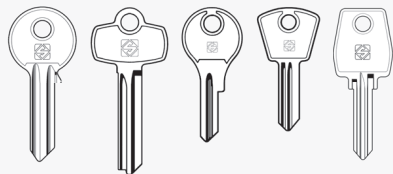
KEYS CUT WITH THE V4 CLAMP**KEYS AUTOMATICALLY PROCESSED WITH STACKER, FEEDER AND SORTER****KEYS CUT WITH THE OPTIONAL V2 CLAMP**

CE Unocode F900 has been designed and manufactured in conformity with CE mark European standards.

USER-FRIENDLY SOFTWARE INTERFACE

- Intuitive software interface developed for the needs of professional locksmiths, with shortcuts to the most used cutting cards and job queues
- Works in stand-alone
- Compatible with SKP Pro to work with existing data archives and Codemaker cards

PROFESSIONAL DISPLAY

- Integrated, industrial 10-inch, touch-screen display
- Tilts to give the perfect viewing angle
- Immediate response to the touch (0,01 seconds)
- Colour display with a resolution of 1280x800 pixels

**FULL CONNECTIVITY**

- Connection both via Wi-Fi and via Ethernet to the local LAN Network
- 4 USB ports (2 ports 3.0 + 2 ports 2.0)
- HDMI port to connect an external screen
- Possibility to connect a wireless keyboard and mouse

CLEANER, SAFER AND MORE COMFORTABLE WORKING AREA

- The machine is completely enclosed: swarf is collected in the tray below the cutting area to leave the working area clean
- The safety shield closes and opens automatically when starting or ending a cycle
- The shield features two microswitches and stops automatically if obstructed to give additional protection
- 55% bigger working area compared to previous models for easier operation



QUIET

- New structure optimized to absorb vibrations and noise
- Less vibrations thanks to the new 80 teeth cutter in hard metal (widia)
- A completely enclosed working area reduces noise during marking and cutting

TOP PERFORMANCE

- Precision cutting and engraving
- Fully automated cutting, marking and sorting processes
- Automatic key feeding in 10 seconds

AUTOMATED, DOUBLE-SIDED MARKING

- Dramatically reduces process time: no need to install a separate tool or to move the key manually
- Avoids mistakes in a manual process, especially when engraving Master Key Systems
- Both key sides can be independently marked

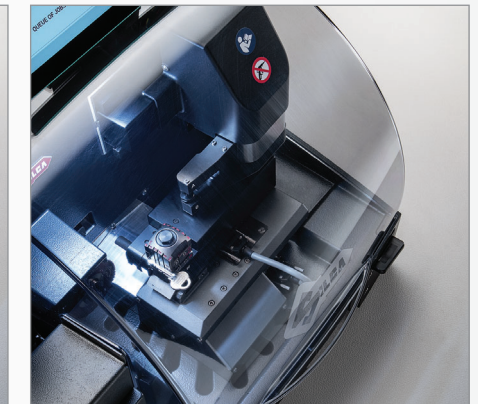
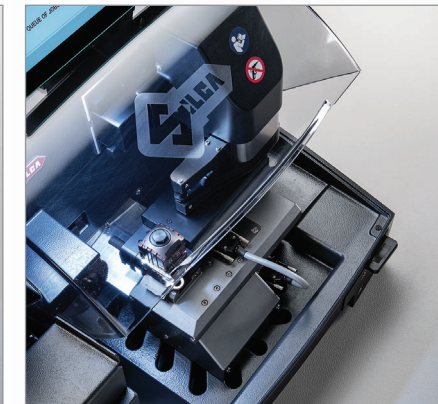
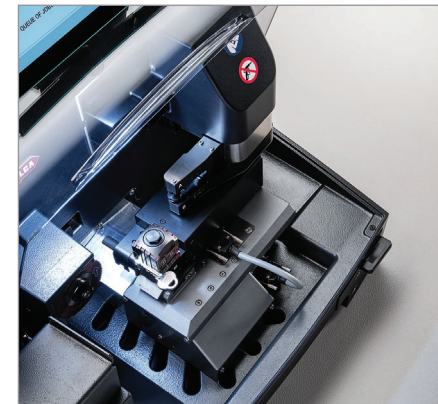
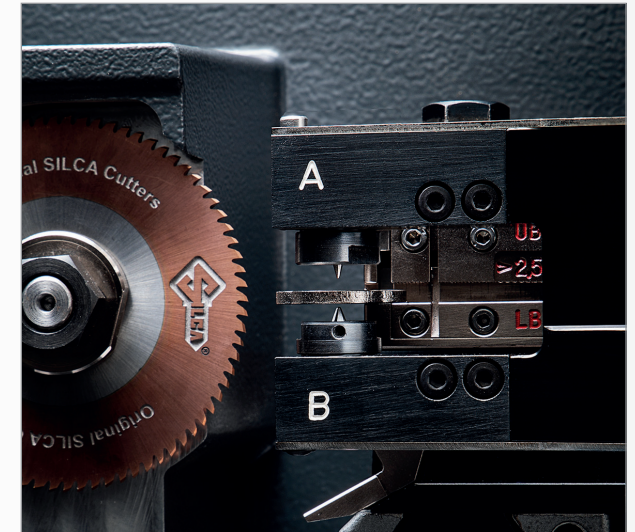

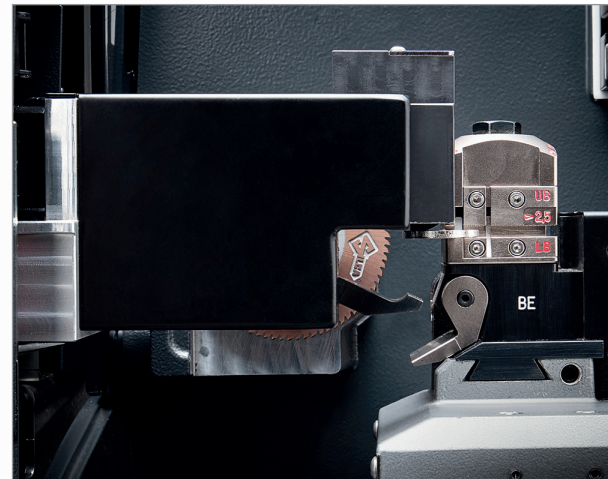
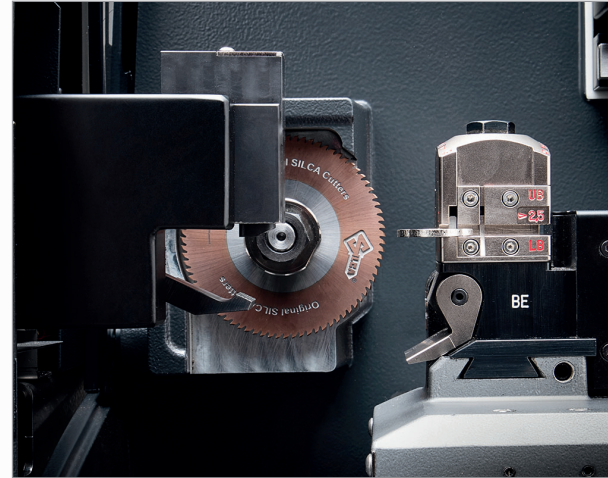

ROBOTIZED FEEDING, PROCESSING AND SORTING

- Automatic feeder is always available. No time wasted on installation
- Stacker and First-In-First-Out "FIFO" sorter process around 100 keys at a time
- No air compressor needed
- Possible to manually cut keys without removing the feeder
- Front facing sorter for ease of access
- Sorter equipped with a sensor to detect when full
- Stacker can be removed for easy filling



CAMERA READER FOR FAST OPTICAL DECODING

- Unique, patent-pending solution for immediate decoding
- No positioning needed: just drop the key in the pull-out compartment
- The software shows the difference between the depths read and the depths defined by the manufacturer
- Double-sided keys with asymmetrical cuts and single-sided keys with protrusions such as ball bearings or other patented design elements cannot be decoded



CUSTOMIZABLE CLAMP

- The specially designed upper and lower jaws mean the clamp can be customized on two sides to take special key profiles
- The modular jaw system means that the capability of the F900 can be expanded according to market developments
- Optional jaws are available to cut systems including Cisa® TSP and SP, Assa® D12 and DP Cliq, Dom® RS8, Abus® XY14/Y14 and Winkhaus® RPE-RPS amongst others
- The standard V4 clamp holds residential keys from 1 to 4 mm thick whereas the feeder manages keys ranging from 1.8 to 4 mm thick



UNOCODE F900 SOFTWARE

For the Unocode F Series key machines we have developed an entirely new software, engineered specifically to make your job easier and quicker. The new interface can also be customized according to your needs, so that you can keep within easy reach the functions you use most frequently.

- Cutting cards comparison available on board
- Cutting cards shortlist*: when decoding a key, you don't have to select a cutting card first. The camera reader decodes the key cuts and provides you with a shortlist of cards from which you can choose the one you need
- Code tables available on board*
- Customize your favourites: you can rename the cutting cards you use most frequently and reorder them according to your needs
- Onboard video tutorials and product manual
- Remote service to support you when needed

* Coming soon with a software update

CUTTING CARD

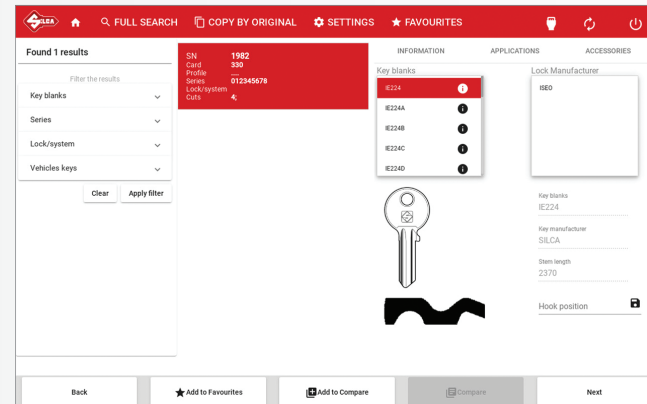

CUT PREVIEW

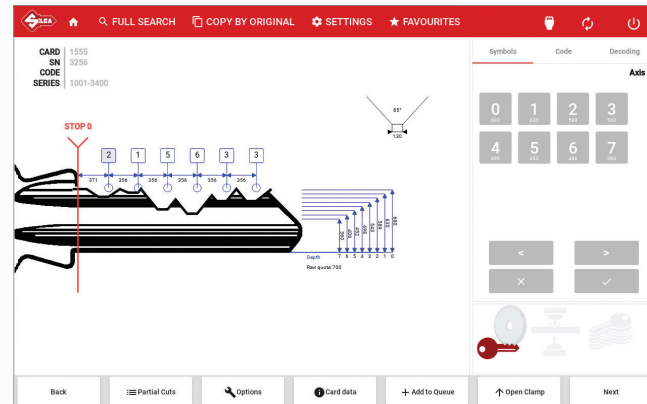

CAMERA READER

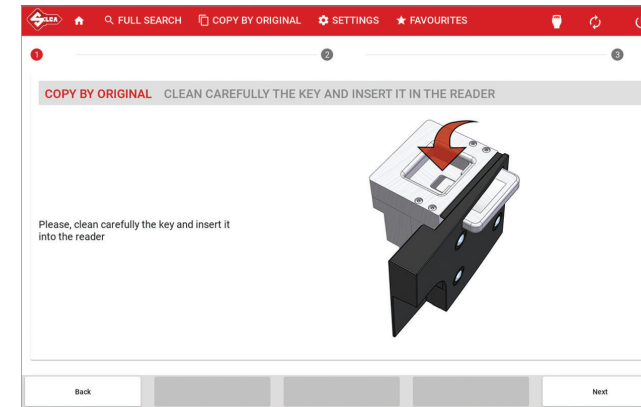

FAVOURITES

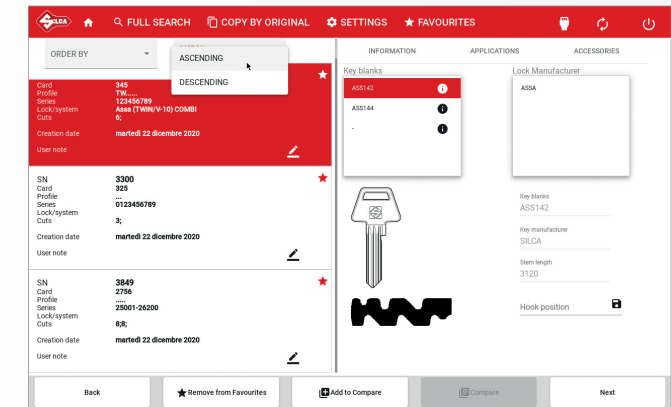

CUTTING CARD COMPARISON

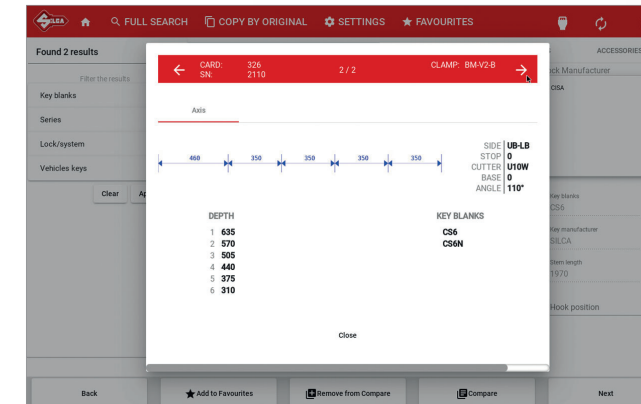





Performance



Video Help



Compatible with SKP Pro



Remote Assistance



Speed



Safety

UNOCODE **F900** IN NUMBERS

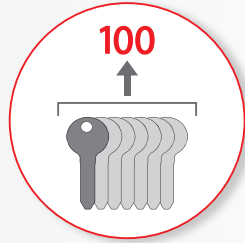

100 keys
feeder capacity with
2.5 mm thick keys

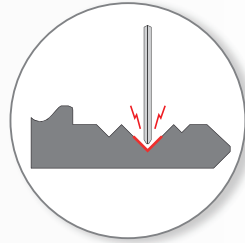

Around 90 keys
with five pins cut and
engraved automatically
per hour

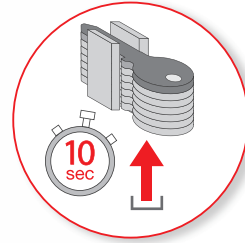

10 seconds max.
for automatic
key feeding

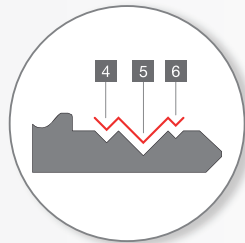

50% faster
key decoding

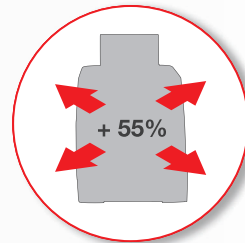

55% bigger
working area

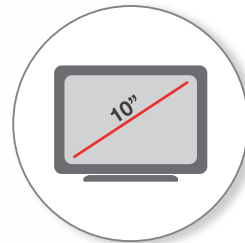

10" display
industrial grade

PATENT PENDING SOLUTIONS

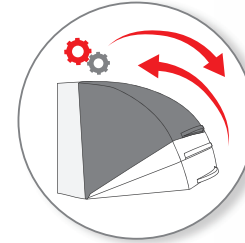

Automatic opening
and closing of
protection shield

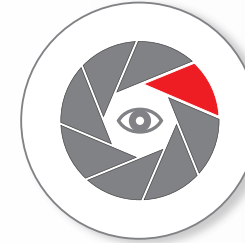

Integrated
camera reader

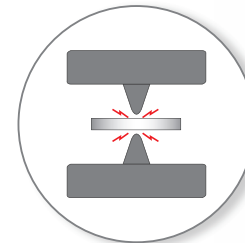

Fully automatic
engraving on
both key sides

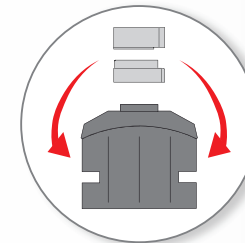

Clamp with two
customizable sides

REGISTERED COMMUNITY DESIGN

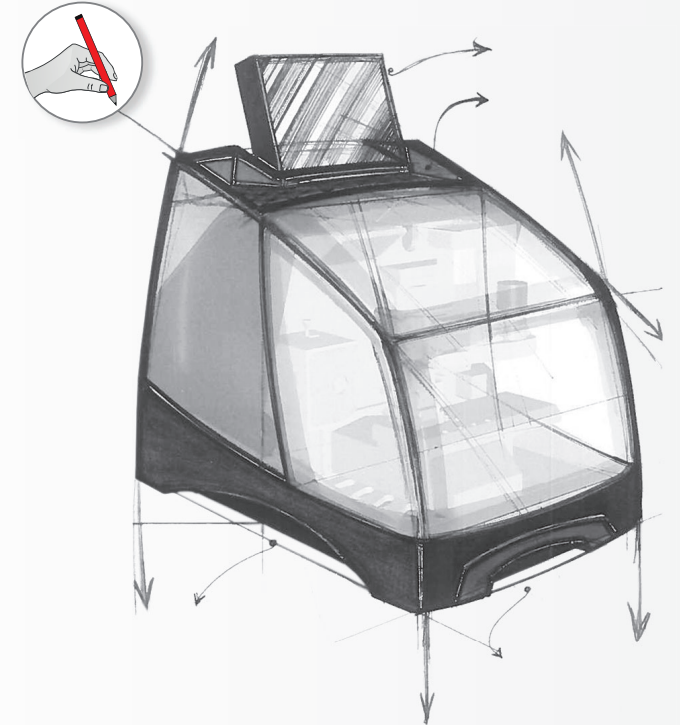

Protecting the Unocode F
Series design in all its versions

TECHNICAL DATA

Electricity supply	100-240V - 50/60Hz
Cutter motor	48VDC
Engraving motor	24VDC
Key cutter	Prismatic in coated hard metal (widia)
Engraving cutters	Upper cutter 'A' in coated hard metal (widia) Lower cutter 'B' in hard metal
Tool speed	Prismatic cutter: 1070 rpm Engraving cutters: 14500 rpm
Movements	On 2 axes with ball screws activated by step motors on ground roller runners. Rotating axis available with optional clamp
V4 clamp	With 4 standard sides for gripping keys with different thicknesses < 2.7: for thicknesses 1 mm to 2.7 mm > 2.5: for thicknesses 2.5 mm to 4 mm
Runs	With clamp: X axis: 30 mm, Y axis: 72 mm Keys with head stop: Y axis: max. 45 mm (by copy and by code) Y axis: max. 42 mm (with feeder) Keys with tip stop: Y axis: max. 45 mm (by copy and by code)
Max dimensions	Width: 921 mm - Depth: 740 mm - Height: 680 mm
Weight	Without feeder: 61.7 Kg - With feeder: 87.7 Kg



In compliance with current regulations relating to industrial property, we hereby state that the trade-marks or trade names mentioned in this document are the exclusive property of authorized manufacturers of locks and users. Said trade-marks or trade names are nominated only for the purposes of information so that any lock for which our keys are made can be rapidly identified. This document is reserved exclusively for professional key cutters who use Silca products. / All information and illustrations in this document are for guidance only. Silca reserves the right to alter products designs, dimensions or info to improve the products quality. The contents of this document are fully protected by Copyright and may not be copied or reproduced in any form, without written permission from Silca S.p.A. Any controversy shall be settled by the Courts of Justice where the company has its headquarters, with express exclusion of any other court.